

Things you might want to ask about asthma



This information is from Asthma UK.
We are a charity that helps people with asthma.



EasyRead version

What is asthma?

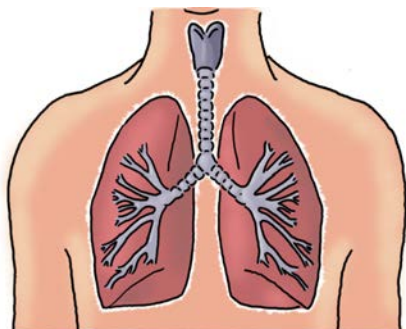

If you have asthma your **airways** do not work well. These are the small tubes that carry air in and out of your lungs when you breathe.



If you have asthma:

- you cough
- you **wheeze** (make a whistling sound when you breathe)
- it is hard to breathe
- your chest feels tight.

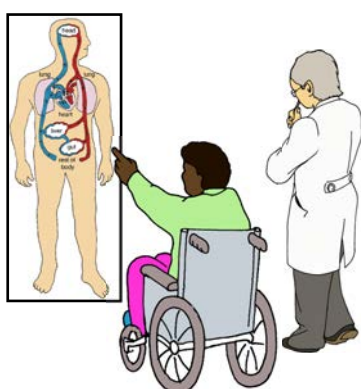

These things are called **symptoms**.

A **symptom** is a problem or feeling that is caused by an illness, disease or long-term condition.

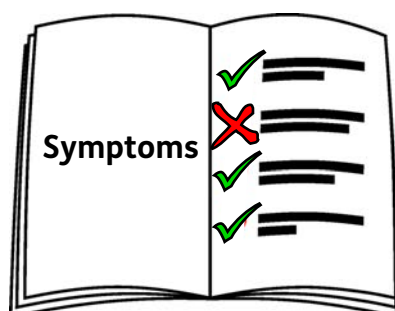

You might get all of these symptoms.

You might only have some of them.

Why do I have asthma?

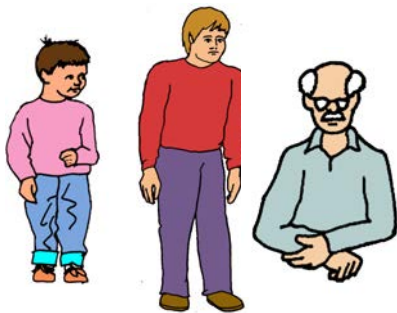

You can get asthma at any age.



You might get asthma if:

- your parents have asthma



- you smoke or someone smokes a lot near you

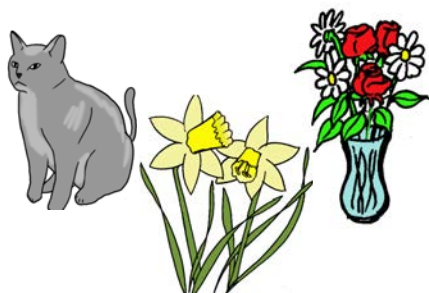

- you have allergies to things. Having an allergy means that something has an unusual affect on you, it could be sneezing or something very serious.



- you breathe in dust or chemicals.



If you smoke when you are pregnant your baby could get asthma.

What can make my asthma worse?



Things that make asthma worse are called **triggers**.

Everyone has different triggers.
Most people have more than one.



Some examples are:

- colds and 'flu



- smoke

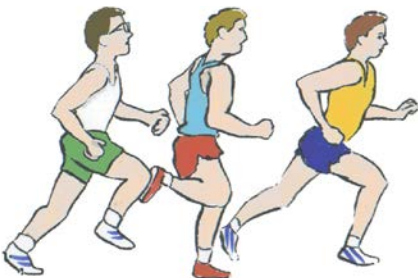

- exercise



- pollen



- mould and damp



- dust

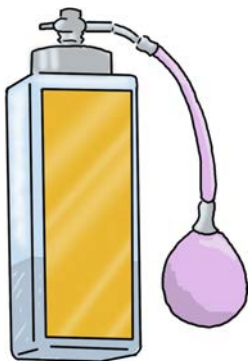

- perfume

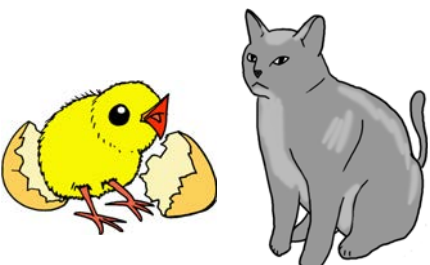

- animals (including birds).

How will asthma affect my life?

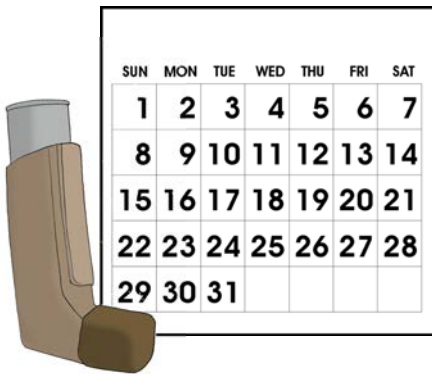

You can still enjoy doing lots of different things if you:

- take your preventer inhaler every day

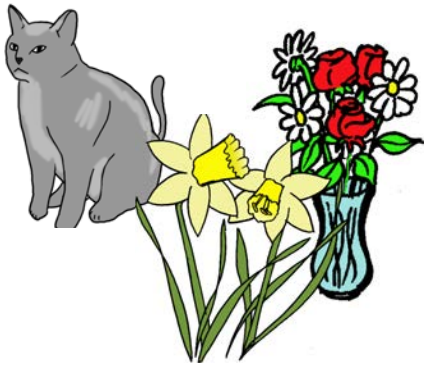

- keep away from things you know are triggers for your asthma



- take your asthma medicines properly.

What can I do to help my asthma?



You can help your asthma by:

- taking your medicines



- talking to your doctor



- using an inhaler card to remind you to use your inhaler

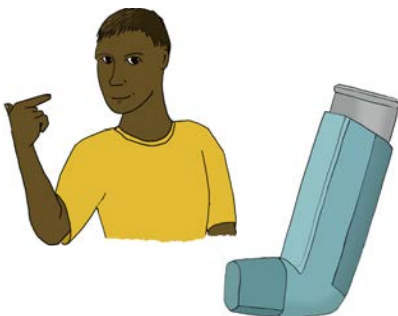

- having your blue inhaler with you all the time.

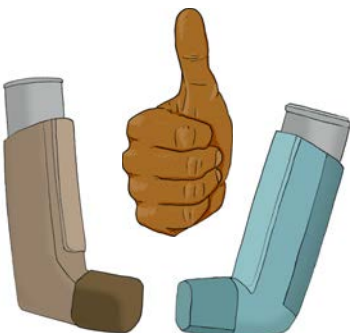

The best medicines for asthma are **inhalers.**

There are 2 types of inhaler:

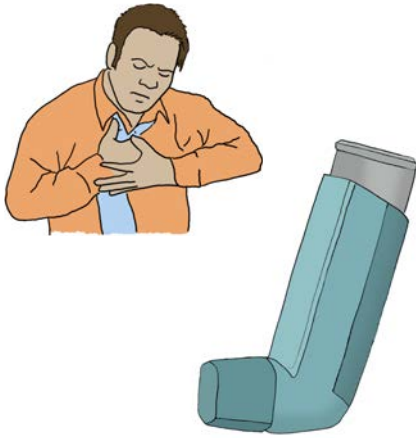

You use a **reliever** inhaler when your asthma feels bad.

It makes it easier to breathe.

It should work straight away.



You use a **preventer** inhaler every day, even if you feel well.

It makes your airways work better.

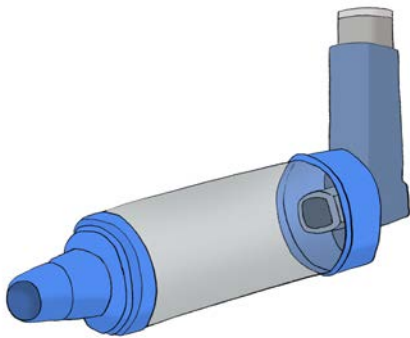

Sometimes you use a **spacer** with an inhaler. This is a plastic tube that helps the medicine get in to your lungs.

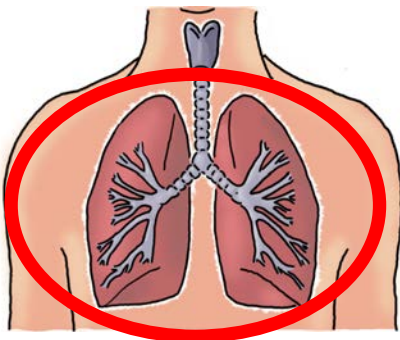

Spacers help you breathe in the medicine and make sure it goes straight to your lungs.



There are different shapes and types of inhaler.

Your doctor or nurse will help you choose the right one for you and show you how to use it properly.



Remember to rinse your mouth out after taking your inhaler.



Can I take tablets to make my asthma better?

Yes. Your doctor might ask you to take tablets every day to help your asthma.



If your asthma is bad you might have to take steroid tablets for a short time as well as your inhaler.



What are steroids?

- steroids work quickly and help you feel better



- they can be an inhaler or tablets



- they are not the same as the illegal steroids that some athletes (sports people) use to make them better at sports.



Sometimes you might get **side effects** from using steroids, but not everyone gets them.

A **side effect** is when you get something unpleasant like a headache or a rash even though the steroids make your asthma better.



Tell your doctor about this straight away.



There are things you can do to make sure the side effects are not too bad. Your doctor or nurse can tell you what these are.

What other things can help my asthma?



Being healthy is good for your asthma.

✓ eat healthy food

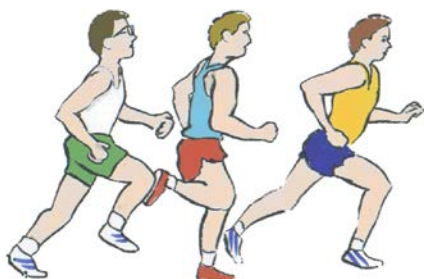

✓ do some exercise



✓ do things that make you happy and relaxed



✓ stop smoking.



If you want to try other treatments like massage or yoga speak to your doctor first.

Breathing exercises can help some people. Keep taking your asthma medicines.

Who can help me look after my asthma?

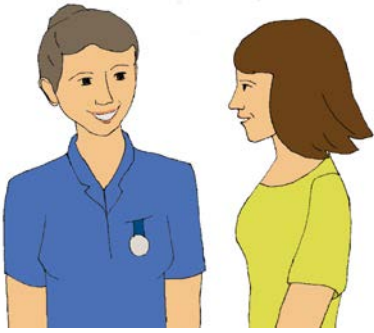

Your doctor or nurse can help you look after your asthma.



Ask them for a **Personal Asthma Action Plan**.

This helps you tell how your asthma is and when it is getting worse.



Every year you should have an asthma check up.

This is called an **asthma review**.



Your doctor will:

- ask you to blow into a tube called a **peak flow meter** to check your breathing



- check you are using your inhaler properly



- see if your asthma is better or worse



- talk to you about looking after your asthma.

How can I tell if my asthma is getting worse?

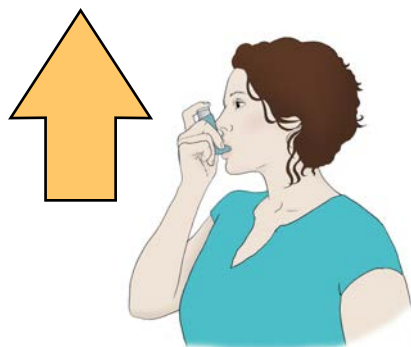

If your asthma is getting worse, you might:

- need to use your blue inhaler more



- be coughing and wheezing



- have a tight chest

- be out of breath a lot



- not be able to do things you can usually do because of your asthma.



If this happens you should see your doctor or nurse as soon as you can.

Your doctor or nurse will help you get your asthma under control again.

What should I do if I have an asthma attack?



If you are having an asthma attack:

- take 2 puffs of your blue reliever inhaler



- sit down and try to relax



- take 1 puff of your blue reliever inhaler every minute until you feel better. You can take up to 10 puffs



999

- phone 999 if you need to take 10 puffs, or if you are worried.



If you have to go into hospital:



- take your inhalers and medicines with you



- go back and see your doctor the next day to check your asthma is ok

1 week						
1	2	3	4	5	6	7
8	9	10	11	12	13	14
15	16	17	18	19	20	
22	23	24	25	26	27	
29	30	31				



- see your doctor again in 1 week to check your asthma is still ok.

If I have a baby will my baby have asthma too?



Asthma can run in families but your baby might not get asthma.

Talk to your doctor if you are pregnant and have asthma. Tell the doctor if you are worried.



You can help your baby by:

✓ not smoking



✓ breastfeeding



✓ still taking your asthma medicines while you are pregnant.

Your asthma medicines will not harm your baby.

Where can I get more information?



You can phone the Asthma UK Adviceline and speak to a nurse about your asthma.

Telephone: **0800 121 62 44**
9am to 5pm, Monday to Friday
(Calls are free from BT landlines)



We can answer calls in different languages.



You can email an asthma nurse through our website at **www.asthma.org.uk**

There is a form to fill in to help us find out about your asthma.



You can ask to see the asthma nurse at you local doctor's surgery.



There is also lots of information on our website:

www.asthma.org.uk



Credits

This paper has been designed and produced for Asthma UK by the EasyRead service at Inspired Services Publishing Ltd. Ref ISL181/11. November 2011.



It has been checked for accessibility by the Making It Easier Group of adults with learning disabilities.



Artwork is from the Valuing People Clipart collection and cannot be used anywhere else without written permission from Inspired Services Publishing Ltd.

To contact Inspired Services:



www.inspiredservices.org.uk

Some of the asthma and inhaler pictures were drawn by Steph Dix and should not be used anywhere else without written permission from Asthma UK.